

# TG39B Series

## TELEVISION INSTRUMENTS

### MULTI TEST SIGNAL GENERATOR



#### General

This TG39B series are designed to support the testing requirements of eight television systems- NTSC-M, NTSC-50 Hz, NTSC-4.43 MHz, NTSC-50 Hz, PAL (European and Asian), PAL-60 Hz, PAL-M, PAL-N and SECAM. This equips the function to generate the video signal, the audio signal (mono), the RF signal, the sound MPX signal (stereo), and the teletext signal, and provides three models as each function. Video signals generated are VBS, GBR, YCbCr and S-VHS (Y/C) signals. They are also equipped with SCART connector outputs. Equipped with over 100 types of standard video output including the Monoscope pattern. This generator can be used for many systems because it is provided with not only various mode selection functions for video signal, but also the scrolling function.

The RF section generates an RF signal of 30 MHz to 955 MHz, and the output level of 29 dB to 109 dB in 0.5 dB steps. A SAW filter is also built into each TV system in this equipment, giving the quality of high accuracy for all broadcasting standards. In addition, since the vision carrier and sound carrier have an inverting function, can be used for the French LOW channel of 100 MHz or less.

The sound MPX function supports China, U.S., Czech, U.K. and other nation's sound MPX system. In addition, the TG39BB and TG39BC types are equipped with the sound encoding function, allowing external L and R sound signals to be input (BTSC is excluded).

The teletext function enables to select one of four coding systems (TOP, FLOF, VBI or Closed Captioning). Selection of PDC or VPS is also possible. Not only pursuing the versatility of TV systems and signal selection but also useful functions and switch arrangement have been considered from the standpoint of operational ease. As the result, the TG39B series are widely applicable as the signal source for R&D, production facility and any other location, which requires a wide range of test signals.

#### Specifications

##### ● Selection guide

Model name	TG39BA	TG39BB	TG39BC
Output signal			
Video signal	A	A	A
Audio signal (Mono)	A	A	A
RF signal	A	A	A
Sound MPX signal (Stereo)	N/A	A	A
Teletext, Closed captioning	N/A	N/A	A

A : Available

N/A : Not available

#### Features

- Support the testing requirements of eight TV systems - NTSC (STD, 50 Hz, 4.43 MHz), PAL (STD, 60 Hz, M, N) and SECAM.
- Equipped with SCART (for European system) and S-VHS each of one connector.
- A WSS (Wide Screen Signalling) signal can be superimposed. The information in the 14 bits can be set individually.
- Scroll function is loaded. Can be set scroll speed (10 steps) and directions arbitrarily.
- The Monoscope pattern and some video patterns have the 4:3 and 16:9 aspect ratio.
- Equipped with the following adjustable function for RF signal parameters:
  - RF level: 29 to 109 dBμ /75 Ω, 0.5 dB step
  - Video RF modulation: 0 to 100%, 0.5% step
  - Audio RF modulation: +/-0.0 to +/-100 kHz, +/-0.5 kHz step
  - 0.0 to 100.0%, 0.5% step
  - P/S ratio: -30 to 0 dB, 0.5 dB step
  - RF frequency: 30 to 955 MHz, 50 kHz step
- Sound MPX functions and Teletext/Closed Captioning functions corresponding to various nations can be equipped.
- It equips with two video signal input (BNC, RCA). An external signal is modulated and can be output as an RF signal. (If external signal input, Teletext signal cannot be added)
- It equips with two audio signal input (BNC, RCA). The external sound signals (AUDIO L and R) is converted to sound MPX signals and can be output as an RF signal. (BTSC is excluded)
- All ratings of the closed captioning V-CHIP are supported. In addition, CC1 to CC4 and T1 to T4 can be set so that they can be set individually.
- The 8/30 Format1 output can be set ON and OFF. In addition, the NI (Network Identification) code can be set to any code.
- With the memory setting operation, 256 ways of setting including TV systems, signals and other conditions can be memorized. Also, equipped with an automatic memory switching function. The memory switching interval can be set within the range of 1 to 3600 seconds.
- The RS232C remote interface is equipped standard. As an option, GP-IB Unit can be built-in.

Specifications

● Specifications

Output signal	Specifications
Number of VBS output	Rear/2 (VBS1, VBS2), Front/1 (VBS3)
VBS output level	VBS1: 1.0 Vp-p 75 Ω VBS2: I/O level ratio = 1:1 (External), same as VBS3 (Internal) VBS3: 1.0 Vp-p 75 Ω (0 to 150% variable)
Number of GBR/YCbCr output	Rear: 1 output each (switchable)
GBR/YCbCr output level Y + Sync signal	NTSC (STD, 4.43 MHz): 1 Vp-p (714.3+285.7 mVp-p) PAL (STD, 60 Hz, M, N): 1 Vp-p (700.0+300.0 mVp-p)
GBR/YCbCr output level CbCr signal	700.0 mVp-p (100% mode) 525.0 mVp-p (75% mode)
GBR/YCbCr output level GBR signal	700.0 mV (G on Sync 1.0 Vp-p)
Number of S-VHS output	Rear/2 (4-pin mini DIN, SCART)
S-VHS output level Y + Sync signal	NTSC (STD, 4.43 MHz): 1 Vp-p (714.3+285.7 mVp-p) PAL (STD, 60 Hz, M, N): 1 Vp-p (700.0+300.0 mVp-p)
S-VHS output signal level C signal	NTSC (STD, 4.43 MHz): 681.2 mVp-p PAL (STD, 60 Hz, M, N), NTSC-50 Hz: 663.8 mVp-p
Number of HS, VS, C.SYNC output	Rear/ 1 output each, more than 1.5 Vp-p/75 Ω
RF output frequency	30 to 955 MHz (in steps of 50 kHz), +/-3 ppm
RF output level	29 to 109 dBμ/75Ω (in steps of 0.5 dB)
RF output characteristic	*Spurious: -60 dB or less (at maximum output setting) DG/DP: 3%/3 degrees or less
RF output P/S ratio	-30 to 0 dB (in steps of 0.5 dB)
Video modulation setting	0 to 100% (in steps of 0.5%)
Audio modulation setting	0 to +/-100 kHz (in steps of +/-0.5 kHz)/0 to 100 % (in steps of 0.5 %)

\* Except higher harmonics wave: -55 dB or less

● Sound MPX signal (TG39BB, TG39BC)

Two-carrier system

TV SYSTEM	NTSC-M	PAL-B/G	SECAM-D/K PAL-D/K
Country	KOREA	GERMAN	CZE
First sound carrier frequency	4.5 MHz	5.5 MHz	6.5 MHz
Second sound carrier frequency	4.724213 MHz	5.7421875 MHz	6.2578125 MHz
1st sound carrier frequency (video ratio)	-13 dB	-13 dB	-13 dB
2nd sound carrier frequency (video ratio)	-20 dB	-20 dB	-20 dB

NICAM system

TV SYSTEM	PAL-B/G/D/K SECAM-L	PAL-I
Country	SCANDINAVIA CHINA FRANCE	U.K.
Sound carrier frequency	5.85 MHz	6.552 MHz
1st sound carrier frequency (video ratio)	-13 dB (SCA, CHN) -10 dB (FRA)	-13 dB
2nd sound carrier frequency (video ratio)	-20 dB (SCA) -25 dB (CHN) -27 dB (FRA)	-20 dB

BTSC/FM-FM system

TV SYSTEM	NTSC-M	PAL-M	NTSC-M
Country	USA	BRAZIL	JAPAN
Sound carrier frequency	4.5 MHz	4.5 MHz	4.5 MHz
Sound carrier level	-10 dB	-10 dB	-10 dB

## Specifications

### ● Teletext, Closed captioning (TG39BC)

	FLOF/TOP	VBI	Closed captioning
TV system	PAL-B/G/D/K/I/N	NTSC-M	NTSC-M
Superimposition line	20H, 21H, 333H, 334H	16H, 279H	21H, 284H (XDS is added)
Number of pictures	21 pages each	9 pages	CC1 to CC4, T1 to T4, XDS
PDC (FLOF)	4 patterns	—	—
VPS (TOP)	16H, 4 patterns	—	—

### ● Standard video signals

Signal select	Aspect ratio	Types of signals	W/B	COMBI	Remarks
CIRCLE	4:3/16:9	1	A	N/A	All patterns can be superimposed.
MARKER	4:3/16:9	1	A	N/A	All patterns can be superimposed.
DOT	4:3/16:9	1	A	N/A	All patterns can be superimposed.
CROSS	4:3/16:9	1	A	N/A	All patterns can be superimposed.
COLORBAR	4:3	8	N/A	A	For NTSC and NTSC-4.43 MHz, includes setup 0% or 7.5%
CHECKER	4:3/16:9	4	N/A	A	
RESOLUTION	4:3	4	N/A	A	
WHITE	4:3	12	N/A	A	
PURITY	4:3	9	N/A	A	
STAIR	4:3	12	N/A	A	
RAMP	4:3	2	N/A	A	
CROSS	4:3/16:9	10	N/A	A	
PATTERN	4:3	15	N/A	N/A	
HLINE	4:3	6	N/A	N/A	
WINDOW	4:3	16	N/A	N/A	
MONOSCOPE	4:3/16:9	2	N/A	N/A	
COMBINATION	4:3/16:9	1	N/A	N/A	

W/B : White/Black inversion

COMBI : Signal where COMBINATION pattern is possible

A : Available

N/A : Not available

### ● Options (Factory installation required)

Model name	Items or Content
TG39AA001	GP-IB unit
TG39AA010	Special pattern (composite color pattern)
TG39AA011	Natural picture (Dining table)
TG39AA012	Natural picture (Stationery)
TG39AA013	Natural picture (Toys)
TG39AA014	Natural picture (Presidential residence)
TG39AA015	Natural picture (Lobster and fruits)
TG39AA016	Natural picture (Chestnuts)
TG39AA017	Natural picture (New year's gift)
TG39AA018	CZP (525 systems/4.2 MHz Max., 625 systems/4.8 MHz Max.)
TG39AA019	VSWEEP (525 systems/4.2 MHz Max., 625 systems/4.8 MHz Max.)
TG39AA020	Natural picture (Skin color chart)
TG39AA021	RETOMA pattern
TG39AA022	Multi pattern (composite color pattern)

Specifications

● General specifications

Memory backup time	longer than 1,000 hours
Operating temperature range	0 to 40 degrees C
Relative humidity	25% to 90% RH (no dew condensation)
Power supply	AC 85 to 264 V, 50/60 Hz
Power consumption	
TG39BA	Max. 95 VA
TG39BB	Max. 100 VA
TG39BC	Max. 100 VA
Dimensions	426(W)×149(H)×360(D) mm
Weight	
TG39AA	Approx. 11 kg
TG39AB	Approx. 11 kg
TG39AC	Approx. 11 kg
Accessories	
	AC power cable 1
	3P-2P conversion connector 1
	Instruction manual 1

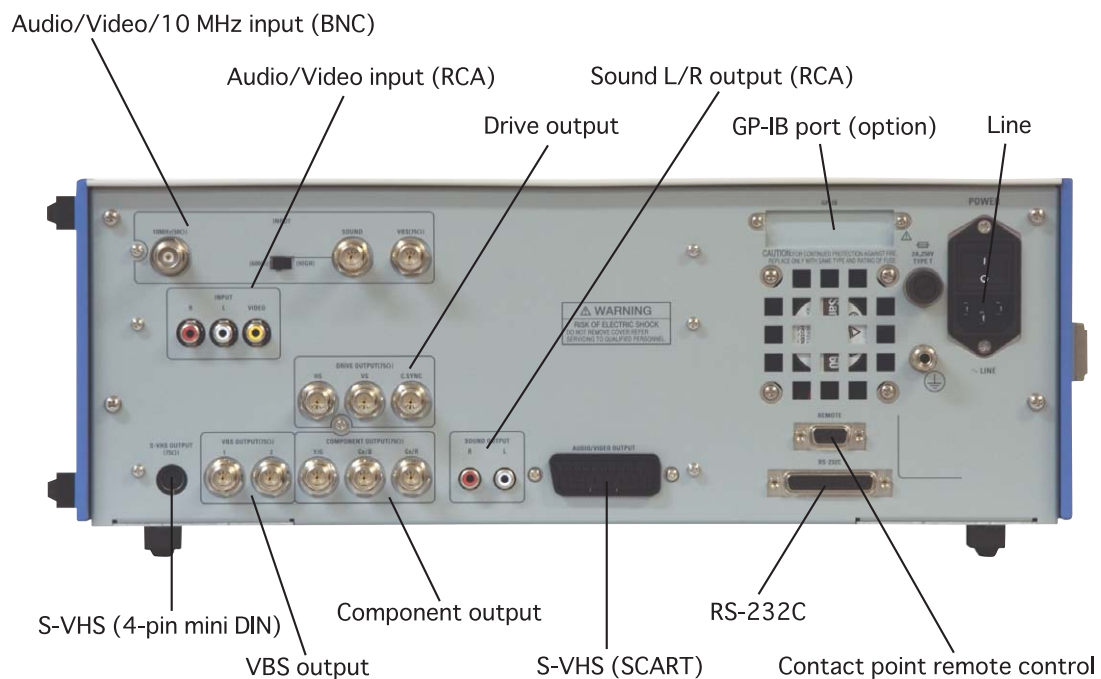

Specifications

● Examples of video signals

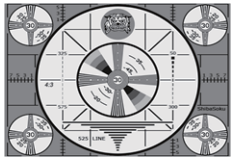

Monoscope Pattern 4:3

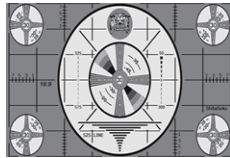

Monoscope Pattern 16:9



Circle 4:3



Circle 16:9



Full Colorbar



8 Colorbar

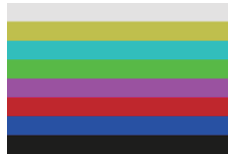

Horizontal Colorbar



Marker

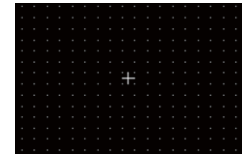

Dot

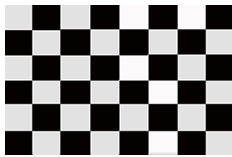

Checker2

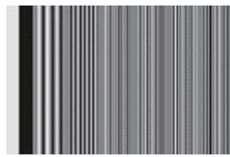

Multi Burst

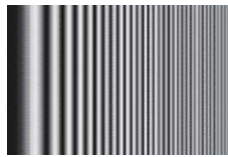

Hsweep



3Line Zebra



Stair5



Vstair10

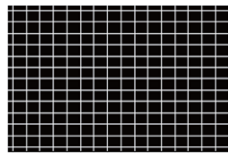

Cross Hatch

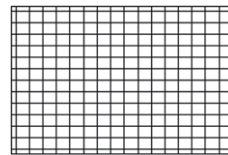

Cross Hatch BK

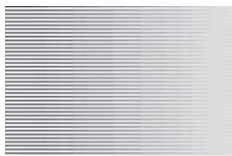

Apl



Pluge

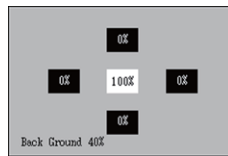

Window Pattern

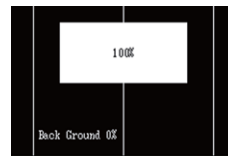

Line&Window



Line Window



Special Pattern  
TG39AA010



Dining Table  
TG39AA011



Stationery  
TG39AA012



Toys  
TG39AA013



Presidential Residence  
TG39AA014



Lobster and Fruits  
TG39AA015



Chestnuts  
TG39AA016



New Year's Gift  
TG39AA017

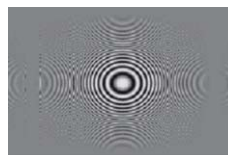

CZP  
TG39AA018



VSWEEP  
TG39AA019



Skin Color Chart



RETOMA Pattern (NTSC)  
TG39AA021



RETOMA Pattern (PAL)  
TG39AA021

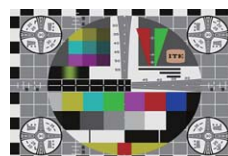

Multi Pattern (NTSC)  
TG39AA022

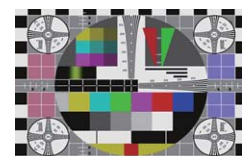

Multi Pattern (PAL)  
TG39AA022